

**Inhalt**  
**Contents**  
**Contenu**

**Inhoud**  
**Contenido**  
**Conteúdo**

**Contenuto**  
**Содержание**  
**目录**

Einzelteilübersicht / Spare parts list / Liste des pièces détachées / Onderdelenoverzicht / Lista da piezas / Resumo de peça individual /  
Singoli componenti / Перечень деталей / 零件概览 ..... 2

Montagetips / Tips for assembly / Tuyaux pour le montage / Montagetips / Consejos para el montaje / "Dicas" para montagem /  
Consigli per il montaggio / Советы по сборке / 装配建议 ..... 3

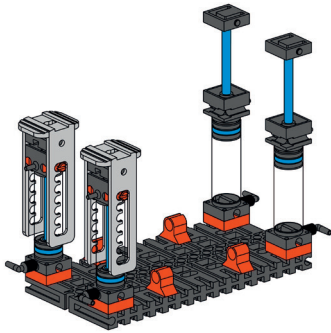

Demomodell / Demo model / Modèle de démonstration /  
Demomodell / Modelo de demostración / Modelo de demonstração /  
Modello dimostrativo / Демонстрационная модель /  
演示模式 ..... 4

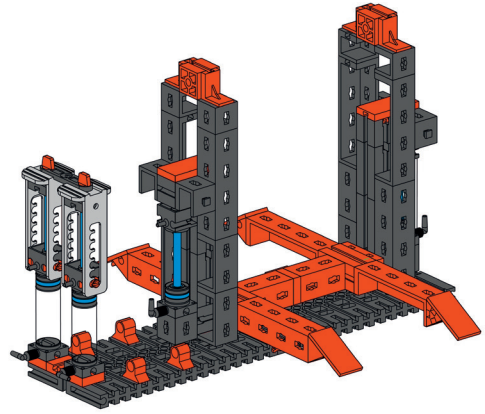

Hebebühne / Lift / Plateforme de levage / Hefplatform /  
Plataforma elevadora / Plataforma elevatória /  
Piattaforma di lavoro aerea / Подъемная платформа /  
升降台 ..... 6

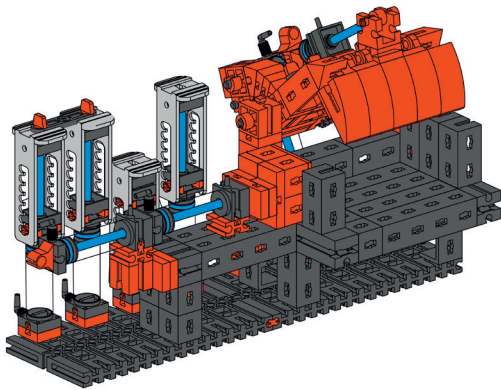

Schrottpresse / Car crusher / Presse à ferraille / Schrootpers /  
Prensa de chatarra / Prensa de sucata / Pressa per rottami /  
Пакетировочный пресс / 废钢打捆压力机 ..... 15

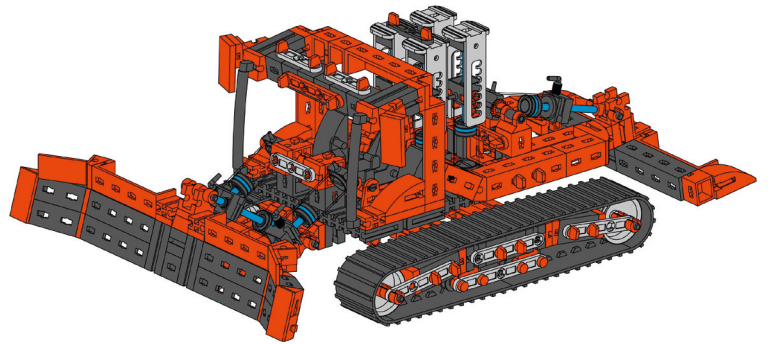

Pistenraupe / Snowcat / Dameuse / Pistenbully / Pisanieves /   
Niveladora de neve / Gatto delle nevi / Гусеничный  
снегоуплотнитель / 雪道推平车 ..... 26

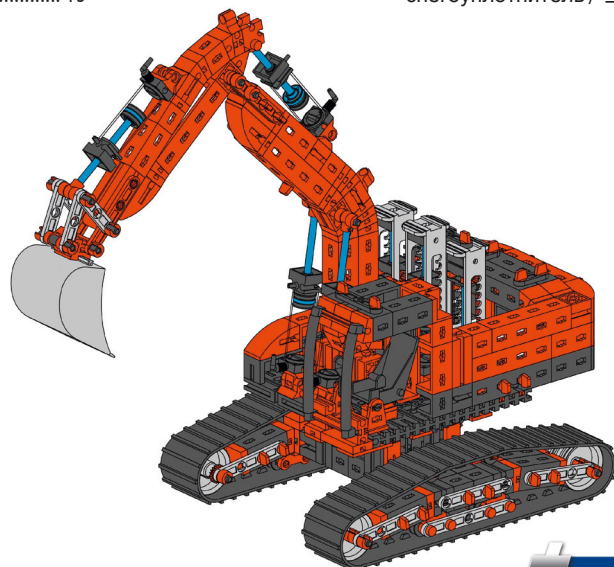















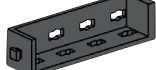
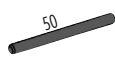



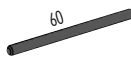

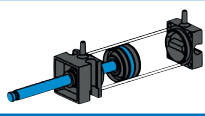

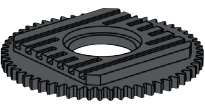



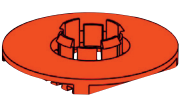

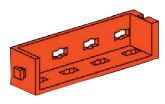





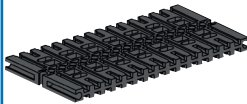





















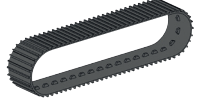













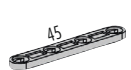

Raupenbagger / Excavator / Pelle sur chenilles /   
Rupsgraafmachine / Excavadora de oruga / Escavadora de  
lagartas / Escavatore cingolato / Экскаватор на  
гусеничном ходу / 履带式挖掘机 ..... 43

**Einzelteilübersicht**  
**Spare parts list**  
**Liste des pièces détachées**

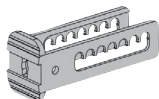
**Onderdelenoverzicht**  
**Lista da piezas**  
**Resumo de peça individual**

**Singoli componenti**  
**Перечень деталей**  
**零件概览**

	31 010 2 x		32 064 7 x		36 920 12 x		38 414 4 x
	31 011 10 x		32 071 16 x		36 921 6 x		38 415 5 x
	31 060 3 x		32 085 4 x		36 922 11 x		38 416 1 x
	31 061 2 x		32 330 2 x		36 938 8 x		38 423 9 x
	31 390 1 x		32 879 8 x		36 950 8 x		38 428 4 x
	31 391 1 x		32 881 6 x		36 973 6 x		78 728 11 x
	31 422 4 x		35 049 2 x		37 237 22 x		116 251 4 x
	31 426 5 x		35 129 2 x		37 238 5 x		116 252 3 x
	31 436 7 x		35 969 6 x		37 468 5 x		116 913 4 x
	31 690 9 x		36 323 40 x		37 636 2 x		127 471 6 x
	31 848 12 x		36 324 4 x		37 679 36 x		127 472 6 x
	31 918 2 x		36 334 6 x		38 240 2 x		139 645 2 x
	31 981 8 x		36 586 4 x		38 241 10 x		146 985 2 x
	31 982 51 x		36 819 2 x		38 246 1 x		156 042 1 x
	31 983 1 x		36 912 4 x		38 253 2 x		156 104 1 x
	31 984 1 x		36 914 2 x		38 258 12 x		160 545 4 x
	31 994 2 x		36 915 8 x		38 413 2 x		160 546 10 x

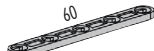
	163 203 4 x		173 040 4 x		173 043 2 x		
	163 439 7 x		173 041 4 x		173 044 6 x		
	172 809 2 x		173 042 1 x		173 045 2 x		

**Montagetipps**  
**Tips for assembly**  
**Tuyaux pour le montage**

**Montagetipps**  
**Consejos para el montaje**  
**"Dicas" para montagem**

**Consigli per il montaggio**  
**Советы по сборке**  
**装配建议**

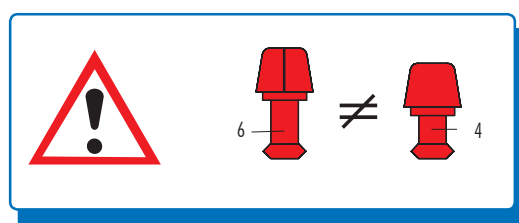
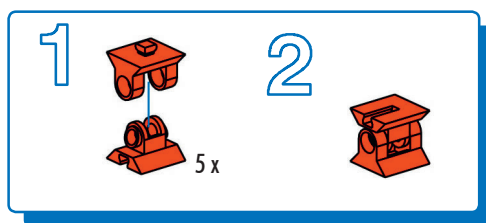
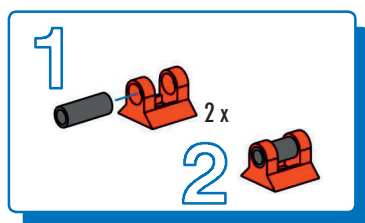
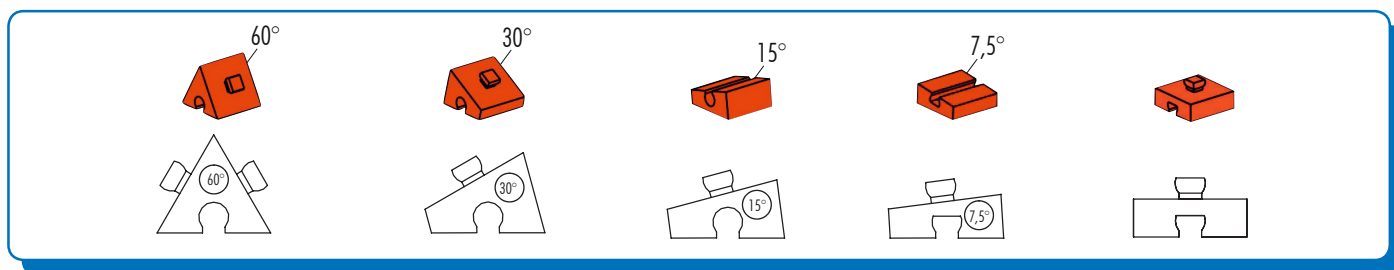

Schlauchzuschnitte  
Hose cut to length  
Découpes de tuyau

Slangdelen  
Recortes de tubos flexibles  
Recortes de mangueira

Spezzoni di tubo  
Штуцеры  
软管段

2 x 25 cm  
1 x 35 cm  
1 x 50 cm

**Sicherheitshinweise**  
**Safety Information**  
**Consignes de sécurité**

**Veiligheidsrichtlijnen**  
**Indicaciones de seguridad**  
**Observações sobre segurança**

**Informazioni per la sicurezza**  
**Указания по технике безопасности**  
**安全指南**

- Alle Einzelteile, insbesondere bewegliche Teile sind falls notwendig zu warten und zu reinigen.
- All components, especially moving parts, should be maintained and cleaned as necessary.
- Toutes les pièces détachées et en particulier les pièces mobiles, sont, si nécessaire, à entretenir et à nettoyer.
- Alle onderdelen, vooral de bewegende delen, kunnen, indien noodzakelijk, onderhouden en gereinigd worden.
- Es necesario limpiar y mantener en buen estado todas las diferentes piezas - especialmente las piezas móviles.
- Caso necessário, todas as peças individuais, especialmente peças móveis, tem que ser submetidas à manutenção e ser limpadas.
- Se necessario, tutti i singoli componenti, soprattutto le parti mobili, si devono eventualmente sottoporre a manutenzione e pulizia.
- Все детали, особенно подвижные, требуют ухода и чистки.
- 必要时应保养和清洁所有零件，尤指运动部件。

25 cm  
20 cm  
15 cm  
10 cm  
5 cm  
0