

Inhalt
Contents
Contenu

Inhoud
Contenido
Conteúdo

Contenuto
Содержание
目录

Einzelteilübersicht / Spare parts list / Liste des pièces détachées / Onderdelenoverzicht / Lista da piezas / Resumo de peça individual /
Singoli componenti / Перечень деталей / 零件概览 2

Montagetips / Tips for assembly / Tuyaux pour le montage / Montagetips / Consejos para el montaje / "Dicas" para montagem /
Consigli per il montaggio / Советы по сборке / 装配建议 3

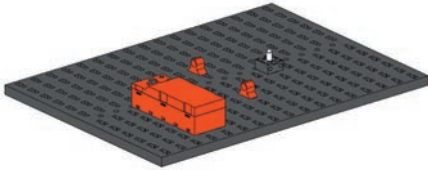

Einfacher Stromkreis / Simple electrical circuit / Simple circuit électrique / Eenvoudig stroomcircuit / Circuito de corriente simple / Circuito eléctrico simples / Circuito elettrico semplice / Простая электрическая цепь / 简单电路6

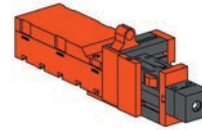

Taschenlampe / Flashlight / Lampe de poche / Zaklamp / Linterna / Lanterna / Torcia elettrica / Настольная лампа / 手电筒7

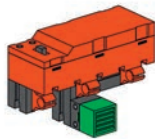

Durchgangsprüfer / Continuity tester / Contrôleur de continuité / Ohmmeter / Probador de continuidad / Dispositivo de teste de continuidade / Misuratore di continuità / Тестер / 断路检测仪8

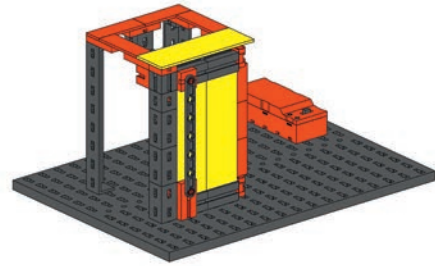

Kühlschrankbeleuchtung / Refrigerator light / Éclairage d'un réfrigérateur / Koelkastverlichting / Iluminación de refrigerador / Iluminação de refrigerador / Illuminazione frigorifero / Освещение холодильника / 冰箱照明灯9

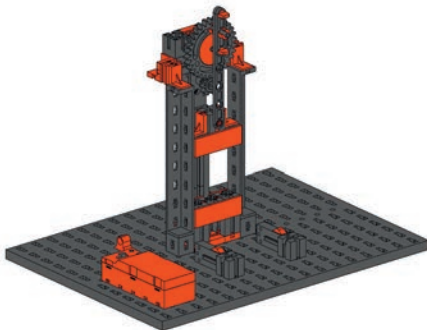

Stanze / Punch / Estampe / Stansmachine / Punzonadora / Punção / Pressa per coniare / Высечной пресс / 冲床13

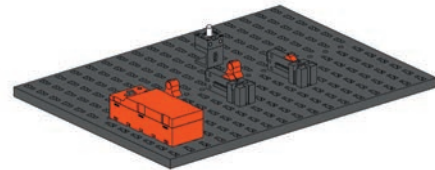

Parallelschaltung / Parallel connection / Montage parallèle / Parallelschakeling / Conexión en paralelo / Conexão em paralelo / Collegamento in parallelo / Параллельное соединение / 并联19

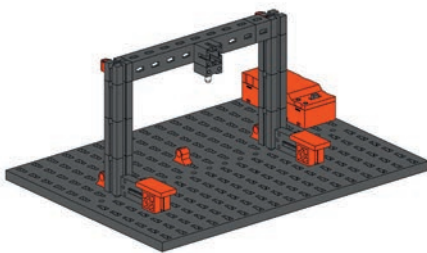

Flurbeleuchtung / Hallway lighting / Éclairage d'un couloir / Vloerverlichting / Iluminación se pasillo / Iluminação de corredor / Illuminazione corridoio / Освещение коридора / 走廊照明灯21

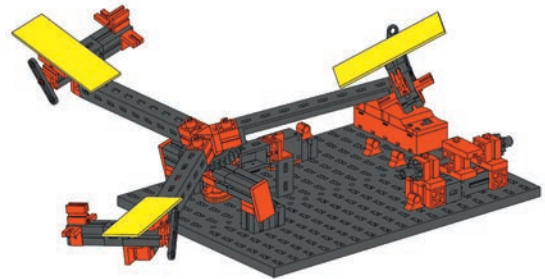

Karussell mit Polwendeschalter / Merry-go-round with pole reversing switch / Manège avec commutateur de polarité / Draaimolen met poolomkeerschakelaar / Tiovivo con interruptor conmutador de polos / Carrossel com comutador / Giostra con invertitore di polarità / Карусель с переключателем полюсов / 配备极性转换开关的旋转木马23

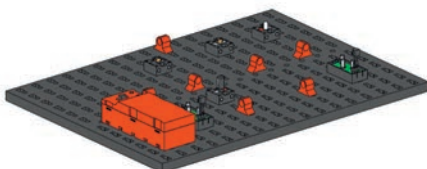

Einfacher Blinker / Simple flasher / Clignotant simple / Eenvoudig knipperlicht / Intermitente sencillo / Pisca-pisca simples / Lampeggiatore semplice / Простая мигалка / 单个闪烁灯28

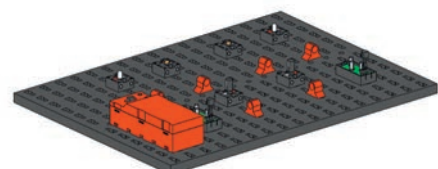

Wechselblinker / Alternating flasher / Clignotant alternatif / Knipperlichtwisselaar / Intermitente alternado / Pisca-pisca comutável / Lampeggiatore alternato / Переменная мигалка / 两个交替的闪烁灯30

Inhalt
Contents
Contenu

Inhoud
Contenido
Conteúdo

Contenuto
Содержание
目录

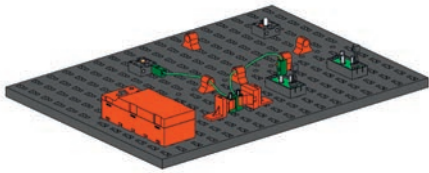

Berührungsschalter / Touch switch / Commutateur tactile / Contactschakelaar / Interruptor de contacto / Interruptor de toque / Interruttore a sfioramento / Сенсорный выключатель / 触摸式开关32



Karussell / Merry-go-round / Manège / Draaimolen / Tiovivo / Carrossel / Giostra / Карусель / 旋转木马34

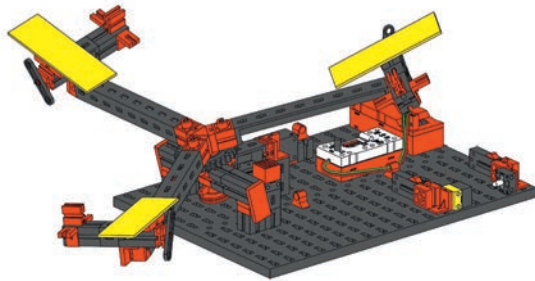

Karussell mit Lichtschranke / Merry-go-round with light barrier / Manège avec barrière lumineuse / Draaimolen met fotocel / Tiovivo con barrera fotoeléctrica / Carrossel com célula fotoelétrica / Giostra con barriera fotoelettrica / Карусель с фоторелейным барьером / 配备光栅的旋转木马36

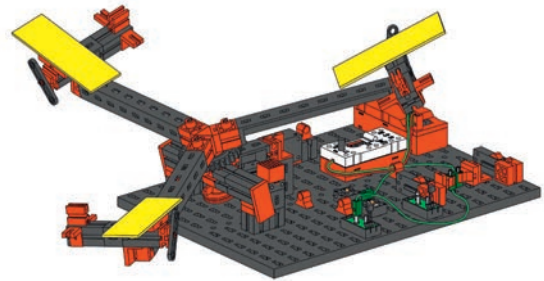

Karussell mit Berührungsschalter / Merry-go-round with touch switch / Manège avec commutateur tactile / Draaimolen met contactschakelaar / Tiovivo con interruptor de contacto / Carrossel com interruptor de toque / Giostra con interruttore a sfioramento / Карусель с сенсорным выключателем / 配备触摸式开关的旋转木马39



Schiffschaukel / Ship see-saw / Bateau-balanoïre / Familieschommel / Columpio de barco / Balanço de barco / Altalena a gondola / Качели / 船形秋千42



Schiffschaukel mit Wechselblinker / Ship see-saw with alternating flasher / Bateau-balanoïre avec clignotant alternant / Familieschommel met knipperlicht-wisselaar / Columpio de barco con intermitente alternado / Balanço de barco com pisca-pisca comutável / Altalena a gondola con lampeggiatore alternato / Качели с переменной мигалкой / 配备单个闪烁灯的船形秋千 ..48

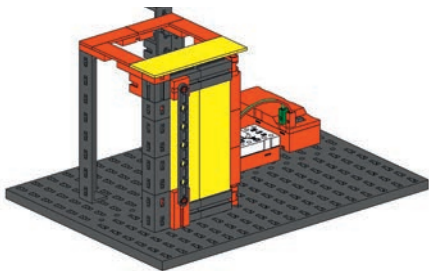

Alarmanlage / Alarm system / Système d'alarme / Alarminstallatie / Instalación de alarma / Equipamento de alarme / Impianto di allarme / Сигнализация / 报 / 警装置50

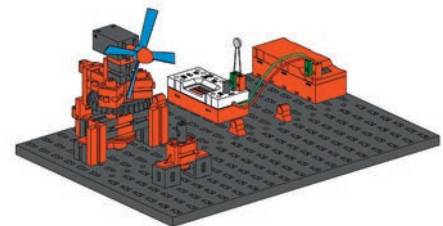

Ventilator / Ventilating fan / Ventilateur / Ventilator / Ventilador / Ventilador / Ventilatore / Вентилятор / 风扇54

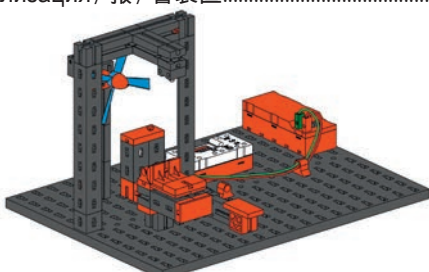

Badezimmerlüftung / Bathroom fan / Ventilation de la salle de bain / Badkamer-ventilating / Ventilación de cuarto de baño / Ventilação de banheiro / Aeratore per bagno / Вентиляция ванной комнаты / 浴室换气扇57

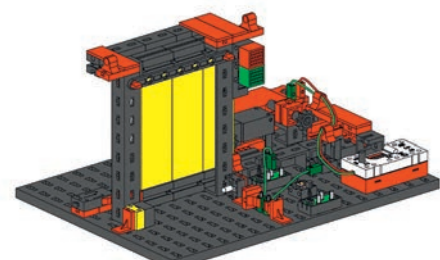

















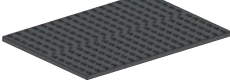









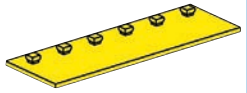





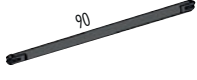

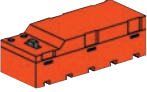















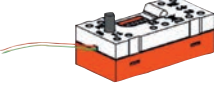















Schiebetür / Sliding door / Porte coulissante / Schuifdeur / Puerta corrediza / Porta corrediça / Porta scorrevole / Сдвижная дверь / 滑门60

Einzelteilübersicht
Spare parts list
Liste des pièces détachées

Onderdelenoverzicht
Lista da piezas
Resumo de peça individual

Singoli componenti
Перечень деталей
零件概览

	31 053 2 x		32 879 8 x		36 437 1 x		38 413 3 x
	31 058 2 x		32 881 8 x		36 443 1 x		38 414 1 x
	31 078 1 x		32 985 1 x		36 532 1 x		38 423 8 x
	31 082 1 x		35 031 2 x		36 912 3 x		38 428 6 x
	31 336 30 x		35 049 5 x		36 920 4 x		38 485 3 x
	31 337 22 x		35 063 1 x		36 922 5 x		38 543 1 x
	31 426 2 x		35 066 1 x		36 981 1 x		135 719 1 x
	31 436 2 x		35 073 1 x		37 237 11 x		136 775 1 x
	31 597 2 x		35 079 1 x		37 468 8 x		137 096 1 x
	31 848 3 x		35 084 1 x		37 679 7 x		152 059 2 x
	31 918 1 x		35 945 2 x		37 681 1 x		152 063 1 x
	31 981 7 x		35 969 8 x		37 783 2 x		152 218 2 x
	31 982 16 x		36 134 1 x		37 875 1 x		152 219 2 x
	31 983 2 x		36 264 1 x		38 216 8 x		152 220 2 x
	32 064 11 x		36 293 3 x		38 240 4 x		152 222 1 x
	32 330 2 x		36 323 2 x		38 241 3 x		152 223 2 x
	32 850 2 x		36 337 1 x		38 242 4 x		152 860 2 x

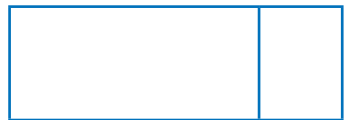
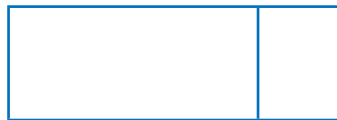
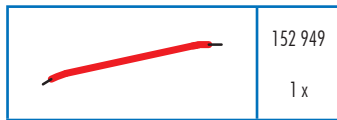
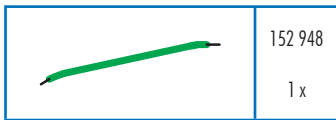

Ratschläge an überwachende Erwachsene

Advice for supervising adults

Recommandations à l'attention des adultes chargés de la surveillance

- Ausschließlich für Kinder von mindestens 8 Jahren geeignet. Die Anleitungen sollen den Erwachsenen befähigen die Experimente im Hinblick auf die Eignung für das betreffende Kind abzuschätzen.
- Not intended for children under 8 years of age. The instructions are intended to enable adults to assess the experiment's suitability for the child concerned.
- Boîte exclusivement appropriée aux enfants de plus de 8 ans. Les instructions devraient permettre aux adultes d'évaluer si l'enfant concerné est apte à effectuer les essais respectifs.

Adviezen voor de volwassene die toezicht houdt

Consejos de supervisión para adultos

Conselhos para os adultos vigilantes

- Uitsluitend geschikt voor kinderen vanaf minimaal 8 jaar. De gebruiksaanwijzingen dienen als hulp voor de volwassene om te kunnen beoordelen of de experimenten geschikt zijn voor het desbetreffende kind.
- Adecuado exclusivamente para niños de mínimo de 8 años. Las instrucciones deben facultar al adulto de evaluar el experimento con miras a su adecuación para el niño afectado.
- Adequado exclusivamente para crianças com, no mínimo, 8 anos. As instruções devem capacitar os adultos a avaliar os experimentos em relação à sua adequação para a criança pertinente.

Consigli per gli adulti che sorvegliano

Советы контролирующим взрослым

给进行监督的成人的建议

- Adatti esclusivamente per bambini di almeno 8 anni di età. I manuali devono consentire all'adulto di saper valutare gli esperimenti in merito alla loro adeguatezza per il bambino in questione.
- Только для детей старше 8 лет. Эти инструкции дают взрослым возможность оценить эксперименты с точки зрения их пригодности для ребёнка.
- 只适合于 8 岁以上的儿童。说明书应该能让成人判断该实验是否适合想做实验的孩子玩。

Montagetipps

Tips for assembly

Tuyaux pour le montage

Montagetips

Consejos para el montaje

"Dicas" para montagem

Consigli per il montaggio

Советы по сборке

装配建议

Kabel und Stecker
Plugs and cables
Fiches et des câbles

Stekkers en cables
Enchufes en cables
Cabos e contatos

Cavi e conettori
Провода и штекеры
电缆和插头

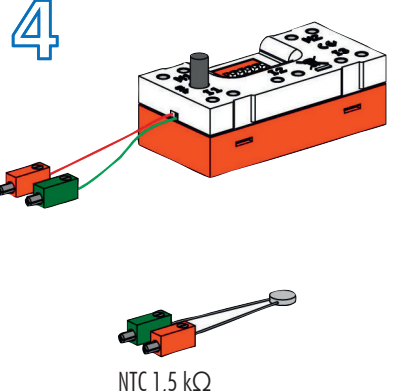
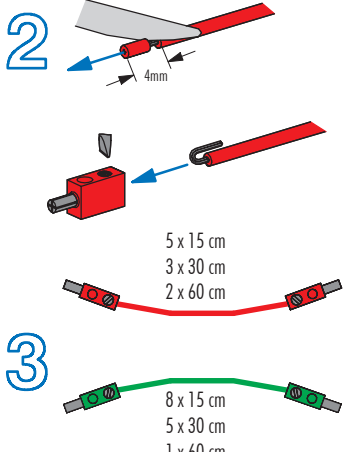
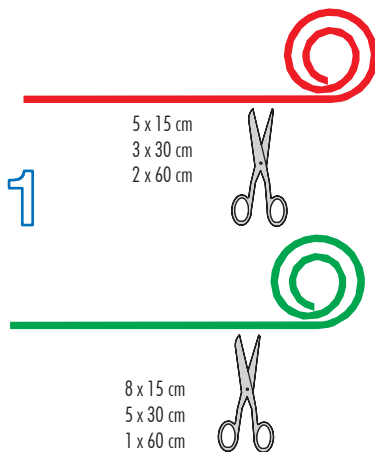

Fototransistor
Phototransistor
Phototransistor
Fototransistor
Fototransistores
Fototransistor
Fototransistor
Фототранзистор
光电晶体管



LED
LED
DEL
LED
LED
LED
LED
LED
Светодиод
LED

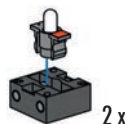

2 x

Achtung: Beim Anschluß auf richtige Polung achten. Rot = +
Caution: Make sure the terminals are connected correctly. Red = +
Attention: lors du raccordement, veiller à ce que la polarisation soit exacte, rouge = +
Pas op: let bij het aansluiten op de juiste polariteit, rood = +
Atención: al conectar, procurar que los polos estén correctamente colocados, roja = +
Atenção: Por ocasião da conexão atentar para a polaridade correta. Vermelho = +
Attenzione: nel collegamento osservare la corretta polarità. Rosso = +
Внимание: при подключении соблюдать полярность. Красный = +
注意: 连接时应注意极性正确。红色 = +

Kondensator 10µF/35V
Capacitor 10µF/35V
Condensateur 10 µF / 35 V
Condensator 10µF/35V
Condensador 10µF/35V
Condensador 10µF/35V
Condensatore 10µF/35V
Конденсатор 10 мкФ/35 В
电容 10µF/35V

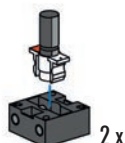

2 x

