

Inhalt
Contents
Contenu

Inhoud
Contenido
Conteúdo

Contenuto
Содержание
目录

Einzelteilübersicht / Spare parts list / Liste des pièces détachées / Onderdelenoverzicht / Lista da peças / Resumo de peça individual /
Singoli componenti / Перечень деталей / 零件概览 2

Montagetips / Tips for assembly / Tuyaux pour le montage / Montagetips / Consejos para el montaje / "Dicas" para montagem /
Consigli per il montaggio / Советы по сборке / 装配建议 3

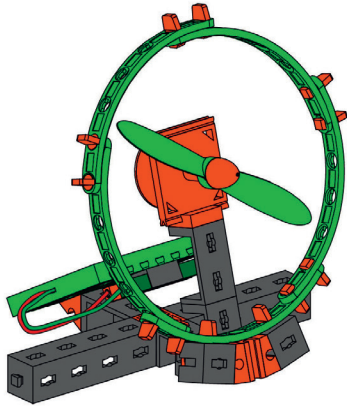

Ventilator / Ventilating fan / Ventilateur / Ventilator / Ventilador /
Ventilador / Ventola / Вентилятор / 风扇 4

Solarfahrzeug / Solar vehicle / Véhicule solaire / Voertuig op zonne-energie /
Vehículo solar / Veículo solar / Veicolo ad energia solare / Электромобиль
с солнечными батареями / 太阳能电动车 6

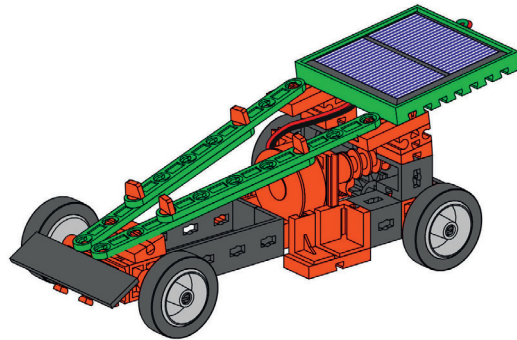



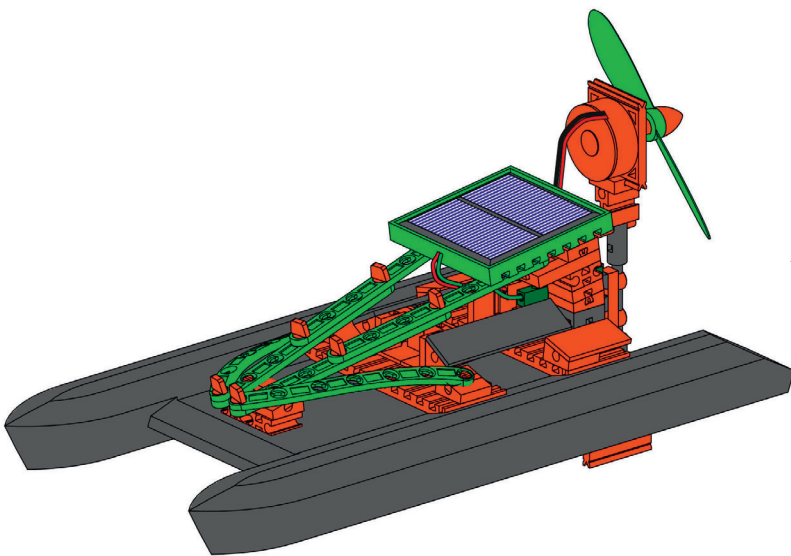



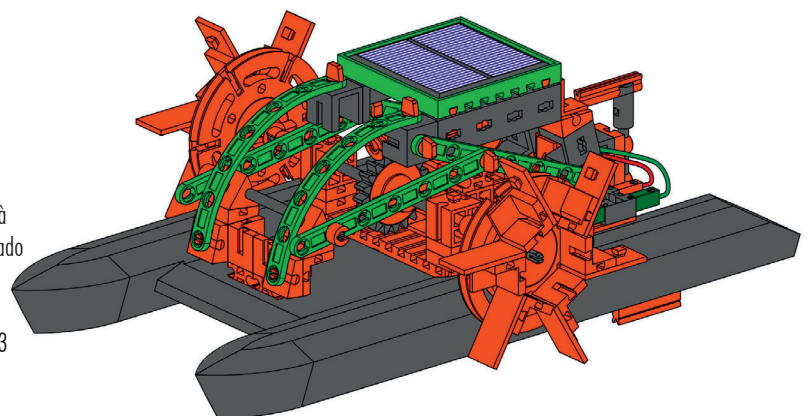



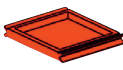

Solarkatamaran / Solar catamaran / Catamaran solaire / Catamaran op
zonne-energie / Catamarán solar / Catamarã solar / Catamarano solare /
Катамаран с солнечными батареями /
太阳能双体船 9





Solarbetriebenes Schaufelradboot / Solar-powered paddle wheel boat / Bateau à
aubes solaire / Raderboot op zonne-energie / Bote de rodas de paletas impulsado
por energia solar / Barco de roda de pá solar / Barca con ruota a pale a energia
solare / Колёсный катер на солнечных батареях /
太阳能驱动的明轮船 13









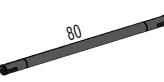



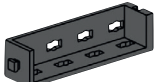

Einzelteilübersicht
Spare parts list
Liste des pièces détachées

	31 010 2 x
	31 013 1 x
	31 019 2 x
	31 021 1 x
	31 058 3 x
	31 061 1 x
	31 336 2 x
	31 337 2 x
	31 848 6 x
	31 915 1 x
	31 981 6 x
	31 982 4 x
	31 983 2 x

Onderdelenoverzicht
Lista da piezas
Resumo de peça individual

	32 064 4 x
	32 071 2 x
	32 859 2 x
	34 995 4 x
	35 031 3 x
	35 049 3 x
	35 064 1 x
	35 065 1 x
	35 405 1 x
	35 945 1 x
	35 980 2 x
	36 227 2 x
	36 323 12 x

	36 334 2 x
	36 443 1 x
	36 920 2 x
	36 921 2 x
	36 922 5 x
	37 034 3 x
	37 237 5 x
	37 468 6 x
	37 527 1 x
	37 679 6 x
	37 681 1 x
	37 858 1 x
	38 216 1 x

Singoli componenti
Перечень деталей
零件概览

	38 240 18 x
	38 241 17 x
	38 423 4 x
	38 428 2 x
	133 008 2 x
	143 236 6 x
	146 535 4 x
	155 903 1 x
	156 108 1 x
	156 121 1 x
	156 494 1 x

- Alle Einzelteile, insbesondere bewegliche Teile sind falls notwendig zu warten und zu reinigen.
- All components, especially moving parts, should be maintained and cleaned as necessary.
- Toutes les pièces détachées et en particulier les pièces mobiles, sont, si nécessaire, à entretenir et à nettoyer.
- Alle onderdelen, vooral de bewegende delen, kunnen, indien noodzakelijk, onderhouden en gereinigd worden.
- Es necesario limpiar y mantener en buen estado todas las diferentes piezas - especialmente las piezas móviles.

- Caso necessário, todas as peças individuais, especialmente peças móveis, tem que ser submetidas à manutenção e ser limpadas.
- Se necessario, tutti i singoli componenti, soprattutto le parti mobili, si devono eventualmente sottoporre a manutenzione e pulizia.
- Все детали, особенно подвижные, требуют ухода и чистки.
- 必要时应保养和清洁所有零件，尤指运动部件。